

DESCRIPTION

The 6392 series mop receptor is an all stainless steel mop receptor designed for use in commercial settings. This unit provides a very durable and sanitary unit.

SPECIFICATION

The 6392 series mop receptor is constructed of 16 ga stainless steel type 304. All exposed surfaces are polished to a #4 satin finish. Aprons are provided on three sides. This fixture is coated with a fire resistant sound deadener. A 2" brass caulk drain with a removable stainless steel grid strainer is provided with the unit.

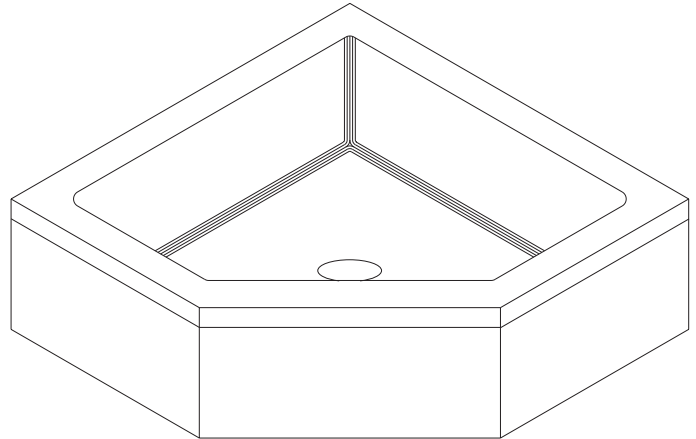

Unit may be pictured with some optional features.

SIZES

- 6392-1 - - - 24" x 24" x 6"
- 6392-2 - - - 24" x 24" x 12"
- 6392-3 - - - 32" x 32" x 6"
- 6392-4 - - - 32" x 32" x 12"
- 6392-5 - - - 36" x 36" x 6"
- 6392-6 - - - 36" x 36" x 12"
- 6392-Custom (You pick the size)

STANDARD FEATURES

- Fabricated using 16-gauge type 304 stainless steel.
- Aprons provided on three sides.
- Fixture interior is coated with a sound dampening, fire resistant material.
- 2" brass caulk drain w/ removable grid strainer.
- Large radius interior corners for easy cleanability.

OPTIONS & ACCESSORIES

TILE FLANGE:

- Side Back

1" DEEP BACKSPLASH:

- Side Back

Specify Height: _____

A744 1-station stainless steel mop holder

A745 3-station stainless steel mop holder

A746 Hose and Holder Assembly



FIXTURE PLAN VIEW

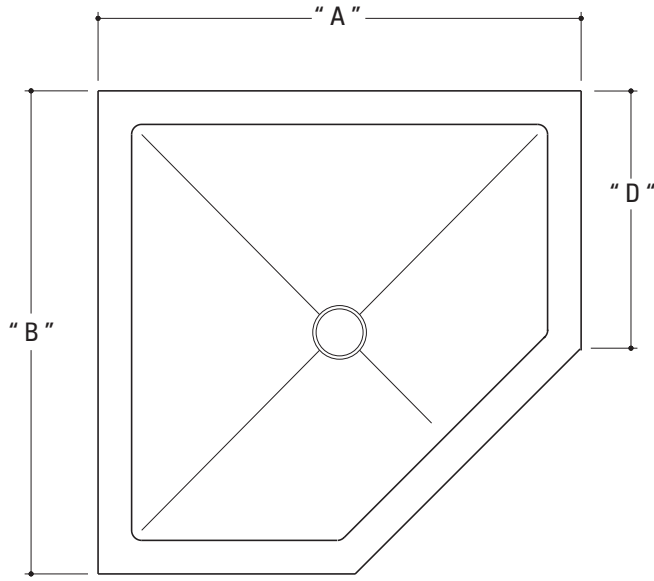

OPTIONAL TILE FLANGE

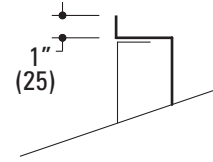

STANDARD EDGE DETAIL

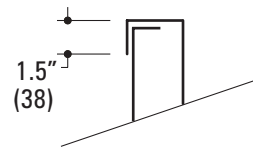

FIXTURE FRONT VIEW

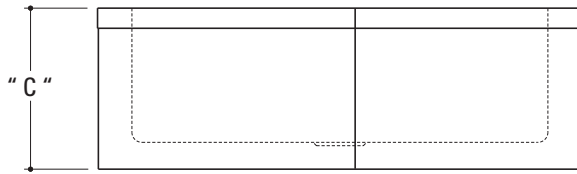

FIXTURE PARTIAL SECTION VIEW

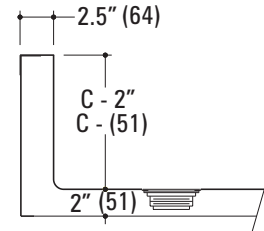

	" A "	" B "	" C "	" D "
6392-1	24" (610)	24" (610)	6" (152)	10" (254)
6392-2	24" (610)	24" (610)	12" (305)	10" (254)
6392-3	32" (813)	32" (813)	6" (152)	18" (457)
6392-4	32" (813)	32" (813)	12" (305)	18" (457)
6392-5	36" (914)	36" (914)	6" (152)	20" (508)
6392-6	36" (914)	36" (914)	12" (305)	20" (508)
6392-custom				

Due to continuous product improvement Metcraft reserves the right to make changes in design and specifications without prior notice. All dimensions should be verified with the factory for current information.

2/2004

METCRAFT

INDUSTRIES INC.

A744

Mop hanger strip with one cam type mop holder. Holder is mounted to a stainless steel mounting bracket that is furnished with two 1/4" mounting holes for securing bracket to wall.

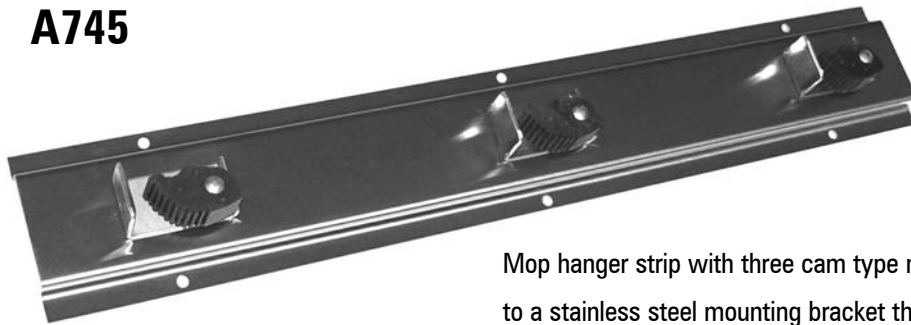
**A745**

Mop hanger strip with three cam type mop holders. Holders are mounted to a stainless steel mounting bracket that is furnished with six 1/4" mounting holes for securing bracket to wall.

A746

3' Heavy garden hose and hose hanger strip with one cam type hose holder. Holder is mounted to a stainless steel mounting bracket that is furnished with two 1/4" mounting holes for securing bracket to wall.



METCRAFT

- I N D U S T R I E S I N C . -